

FILL-RITE®

FUEL MANAGEMENT SYSTEM



NXFM150

**MADE IN
USA** 
WITH GLOBAL MATERIALS

GR
GORMAN-RUPP
COMPANY

Table of Contents

Compatibility / Specs..... 2
 Online Account Setup..... 3
 Warnings..... 3
 NFPA Warnings..... 3
 Wireless Warnings..... 3
 Hazardous Area Examples..... 4
 Site Survey / Where to Install..... 4
 UL / cUL / CE..... 4
 Certifications / Approvals..... 4
 NXFM100 Wiring..... 4-5
 Mounting Dimensions..... 6
 NXFM100 Power On & Verification..... 6
 NXFM150 Wiring..... 6-7
 NXFM150 Power On & Verification..... 7

Welcome to Fill-Rite® FMS! For tech support call: 833-483-5859

NXFM150 Expansion Module

This installation guide contains all of the information you need to install the Expansion Module hardware and expand your Fill-Rite FMS system.

The Fill-Rite FMS expansion system works in tandem with an installed Site Controller to increase the number of pumps you can monitor with Fill-Rite FMS. Ensure that you have completed installation of a Fill-Rite FMS Site Controller before installing your Expansion Module. This includes completing online account setup.

If you have any questions or need help with installation, contact your local Fill-Rite FMS distributor, visit fillrite.com/fms, or call 833-483-5859.

Limited Warranty Policy

Fill-Rite warrants the goods manufactured shall be free from defects of materials and workmanship. Specific warranty details for individual products can be found at fillrite.com.

Privacy Statement

Fill-Rite is committed to protecting user's privacy. For more information about Fill-Rite FMS's privacy policy, please review our full terms and conditions at fillrite.com/fms.



Download the Fill-Rite FMS App



Get Help Installing NXFM150 with the Fill-Rite FMS Installer App



Get Support from the Fill-Rite FMS Help Center

NXFM150 Compatibility & Specs

Power Requirements	80-240V AC, 50/60Hz, 1810W 12V DC 95W [†]
Pump Control Ratings	80-240V AC 7.5A 12V DC 7.5A ^{††}
Dimensions	H: 12" W: 15.5" D: 5.25"
Weather Ratings	NEMA 4X / IP67
Temperature Ratings	-4° F to 122° F (-20° C to 50° C) UL Installations -40° F to 140° F (-40° C to 60° C) non-UL Installations
Pulsar	Power Supply: 12V DC, 100mA Rate: 1:1 to 10,000:1 Speed: 120,000 pulses per minute (2000Hz) Duty Cycle: 50% Contact: (example: reed switch, contact close) Open collector: (wiring example: 12V DC, signal, ground)

[†]DC requires a Class 2 power source (see page 5)

^{††}Ensure NXFM150 DC installations DO NOT exceed 7.5A

Before Installation - Online Account Setup

A fms.fillrite.com account serves as your dashboard to monitor your fuel, manage access permissions, run reports, and control the Fill-Rite FMS. Setting up an online account is easy, and is the first step to activating your Fill-Rite FMS.

Before installation, instruct your Fill-Rite FMS administrator to create a new account at fms.fillrite.com (if they have not already created one). The setup panel will guide administrators through getting their account online. To complete setup, administrators will need:

- The Serial Number of each piece of Fill-Rite FMS hardware being installed, found on the label inside the enclosure
- The street address of each site where Fill-Rite FMS hardware is being installed
- The tank dimensions at each site
- A driver list and vehicle list

Create an Account at fms.fillrite.com

Step 1: Go to fms.fillrite.com with any web browser and click the "Sign Up" button at the bottom of the screen

Step 2: Fill out your company and contact information, and click the "Sign Up" button

Step 3: In the top left corner of the page, underneath the Fill-Rite FMS logo, click the "Setup" button. The Setup page will walk you through all of the necessary steps and features to get your system going. A few of these steps are mandatory for installation, while others can be set up later. For install, here's what you need:

1. Add a Default Payment Method...**Tip:** Go to Settings > Billing in the left navigation
2. Add a Site...**Important:** Ensure that the location address and coordinates for the site are correct
3. Add a Tank...**Tip:** For installation and testing purposes, make sure you've added a tank to your installation site. All other details can be edited at anytime
4. Add Hardware and Configure Relay. Once you've added the hardware, go to Sites > Select a site > Select the "Configuration" tab > Click the settings icon for the relay you want to configure, then select "Configure Relay"...**Important:** To test the app, your Site Controller must be activated and the relay must be configured to your tank

Before Installation - Hardware and Install Warnings

Installations must be in accordance with the National Electrical Code (NFPA No.70) and the code for Motor Fueling Dispensing Facilities and Repair Garages code (NFPA No. 30A). The installer is responsible for investigating and following any applicable state and local codes.

RESTRICTED ACCESS: Access can only be gained by service persons or by users who have been instructed about the reasons for the restrictions applied to the location and about any precautions that shall be taken. Access is through the use of a tool, lock and key, or other means of security, and is controlled by the authority responsible for the location.

Hazardous Area - Where not to mount Site Controller or Expansion Module

DO NOT mount the Site Controller, or any Fill-Rite FMS device within the hazardous / classified area: Class I Div 1 (Zone 1) or Class I Div 2 (Zone 2)

Figure 1

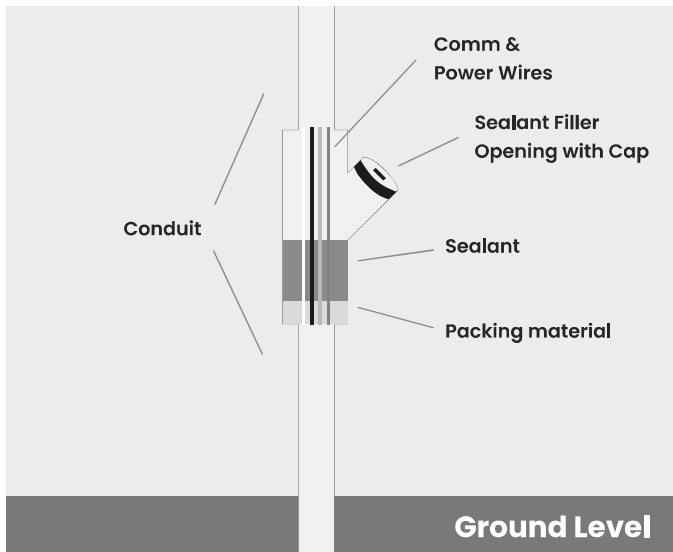

Additional Warnings

External Devices: All peripheral equipment connected to the Site Controller or Expansion Module must be UL or CSA listed.

Hazardous Area Examples

Classified Areas Adjacent to Dispensers

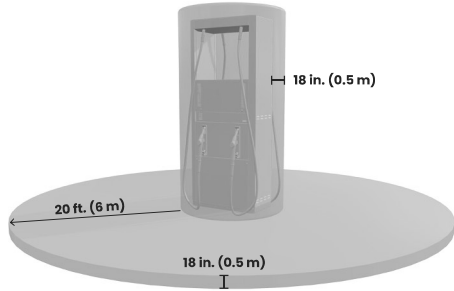

Classified Areas Adjacent to Dispenser Mounted on Above-Ground Storage Tank

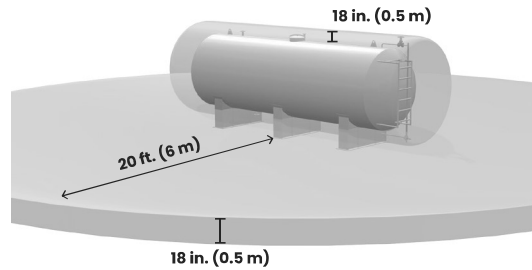

Before Installation - Site Survey

Complete the following steps before beginning installation of Fill-Rite FMS hardware. Failure to perform the below checks may result in the Fill-Rite FMS or fuel equipment being damaged or not working as intended.

1. Turn off all power to the pump and tank
2. Ensure that your installation location meets the following physical requirements:
 - Hardware will be mounted outside of hazardous zones - see warnings for more information
 - **Hardware dimensions for mounting:** NXFM150 - 12.59" H x 10.59" W x 7.11" D
 - Installation location has clear line of site to pump, or is otherwise placed in location where wireless signal will not be blocked or degraded
 - Installation location has no wiring obstructions
 - Installation location has good cellular connectivity
3. Ensure that your site power supply and fuel equipment is compatible with Fill-Rite FMS's hardware. See Compatibility / Specs for more information
4. The Expansion Module needs to be physically connected to the Site Controller through shielded twisted pair RS-485 wire.
5. Fuel within 75' of the Site Controller with good line of site.

Before Installation - Mounting

1. Turn off all power to the pump at the breaker
2. Attach the 4 included Mounting Brackets and screws to the Expansion Module and use any available fasteners to mount the Expansion Module

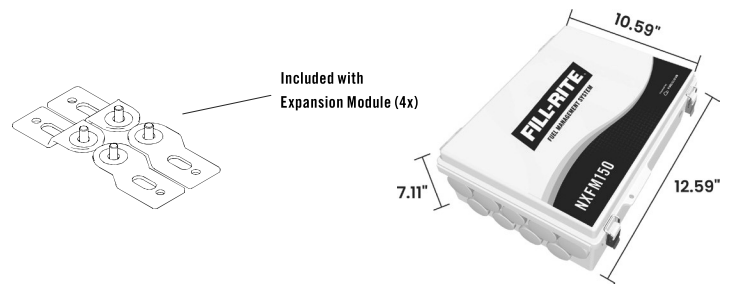

NXFM150 Overview

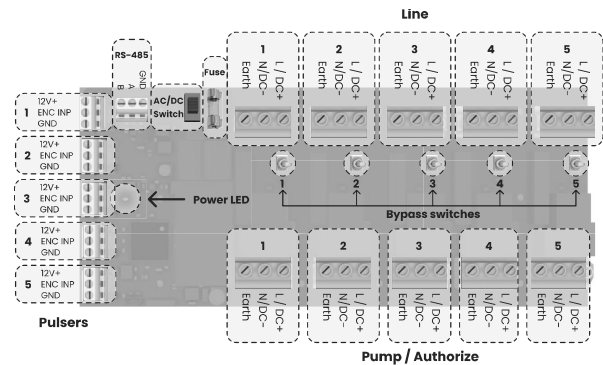

Hardware Installation - Wiring

Fill-Rite FMS Hardware Power In / Power Out

Fill-Rite FMS piggybacks power off of the Hose #1 power input. Your wiring configuration will depend on whether the pump runs on AC or DC power. **Do Not** piggyback input or output wiring unless the wires are sized correctly via NEC.

⚠ WARNING

The Expansion Module requires an external circuit breaker (AC) or fuse (DC) be connected before the input power. It is recommended that the current protection devices are located near the Expansion Module.

Wiring Requirements: All connections to the terminal board must be made using conductors rated 300V minimum.

- Tightening: Min 0.5 Nm, Max 0.6 Nm
- Type: Copper solid or stranded
- Wiring gauge: 10-30 AWG

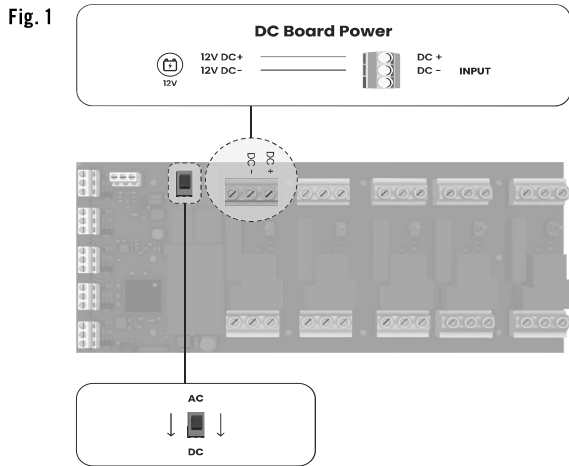

DC

DC power has 8-50V DC positive and negative wires. For power input, attach the appropriate wire to the designated terminals on the top bank of terminals on the Fill-Rite FMS board (see Figure 1).

For power output, attach the appropriate wire to the designated terminal on the bottom bank of terminals on the Fill-Rite FMS board as demonstrated in Figure 1.

For mobile site applications, the Expansion Module switches the pump, PTO, or solenoid on ground. A solenoid valve should be used with a PTO, otherwise fuel can be turned on or off without control from the Fill-Rite FMS app.

NOTE: AC/DC switch only applies to fuel position 1. Fuel positions 2-5 can accept either AC or DC power.

AC

AC power has a line, neutral, and ground wire. For power input, attach the appropriate wires to the designated terminal on the top bank of terminals of the Fill-Rite FMS board (see Figure 2).

NOTE: AC/DC switch only applies to fuel position 1. Fuel positions 2-5 can accept either AC or DC power.

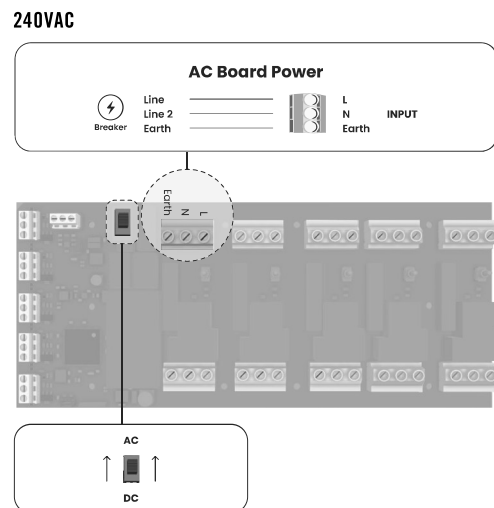
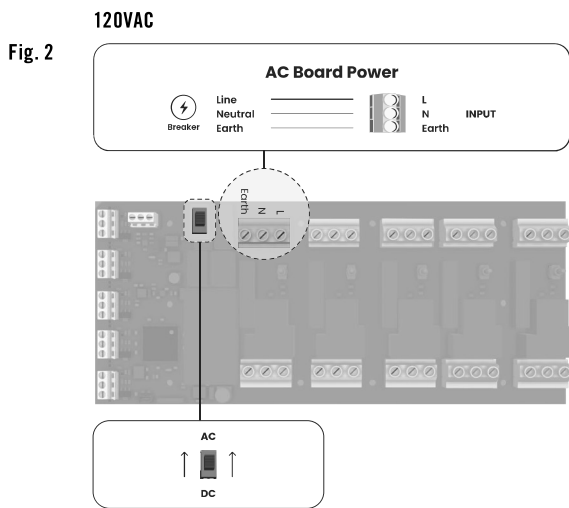

⚠ WARNING

If the switch is in DC position the lamp fuse will blow.

Hardware Installation - Wiring (continued)

RS-485

The Expansion Module and Site Controller must be connected together through RS-485 in order to communicate. Both hardware units have 3 wiring terminals that must be connected to each other. A, B, and GND on the Expansion Module need to be connected to A, B, and GND on the Site Controller.

Multiple NXFM150 Modules can be linked together in a series (up to 10 modules) using RS-485.

⚠ WARNING

Please use a 2 twisted pair and 1 shielded cable for RS485. Example: Beldon 3106a

Site Controller

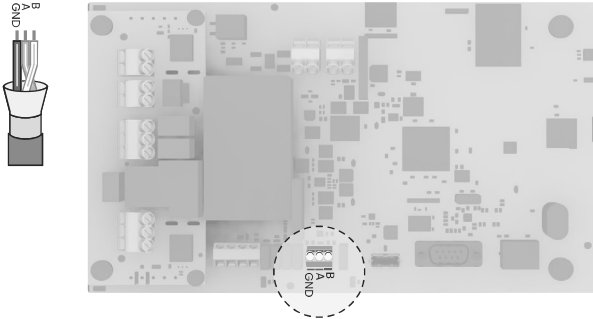

Expansion Module

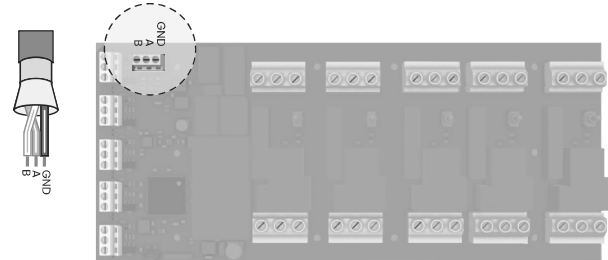

DC Site Wiring

For mobile site applications, the Expansion Module switches the pump, PTO, or solenoid on ground. A solenoid valve should be used with a PTO, otherwise fuel can be turned on or off without control from the Fill-Rite FMS app.

AC Pump Control

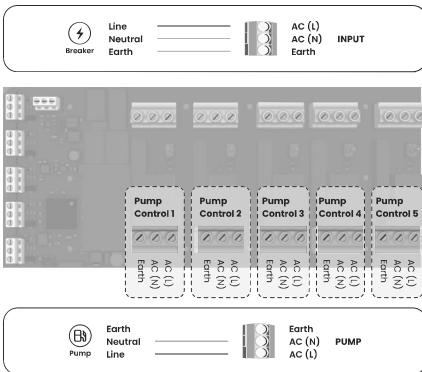

DC Pump Control

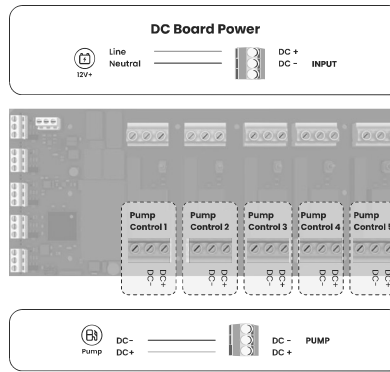

Dispenser Control

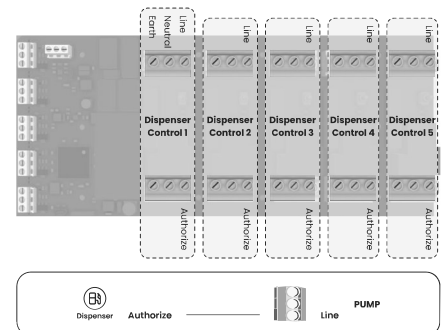

NOTE: There is no connection for handle sense or rest complete. Fill-Rite FMS uses timers and the app to end transactions.

Hardware Installation - Power On & Verification

After installing the Fill-Rite FMS hardware and restoring power to the pump, verify the following items:

1. Power to the Hardware: (AC Power)

Check that the LEDs are illuminated on the Fill-Rite FMS circuit board. If the board does not have power, check that the local circuit breaker has not tripped.

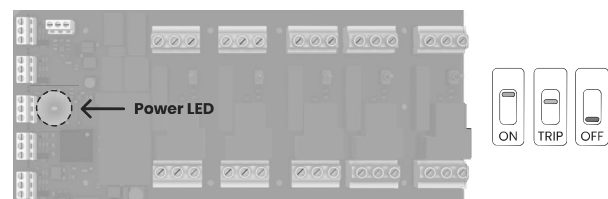

Hardware Installation - Power On & Verification (continued)

2. Bypass Mode:

Flip the bypass switch on the Fill-Rite FMS circuit board, and confirm that your fuel equipment can dispense fuel. Be sure to switch to normal mode after you have successfully tested your equipment.

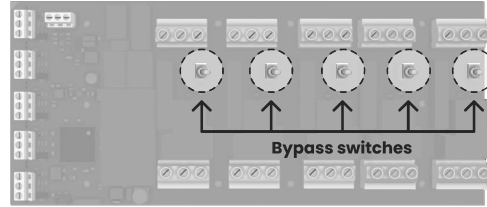

3. Hardware WiFi:

Ensure that your Fill-Rite FMS hardware is successfully broadcasting a wifi signal. On a wifi-enabled device, you should be able to identify and join a wifi network titled "NXFM_XXXXX", where XXXXX is the last five digits of the device's serial number. If using ethernet, connect to your local network.

4. Test Transaction:

Have the Fill-Rite FMS administrator create a driver profile and pin code for you, and perform a test fueling using the Fill-Rite FMS mobile app. The Fill-Rite FMS app may perform a firmware update on first use.

5. Check Pulse Rate:

Confirm that the volume displayed on the Fill-Rite FMS app matches the volume of fluid being dispensed by the equipment. If the volumes do not match, go to fms.fillrite.com, select the site in question, click on the configuration tab, and edit the pump/relay to update the pulse rate.

Hardware Installation - Pulsers

All pulser wire should be shielded twisted pair wire (14-22AWG). Pulser wiring should not share the same conduit as pump AC power. Pulser shield must be connected to Earth on one end only.



WARNING

It's recommended that pulser wire be in a separate conduit than AC wires. If the conduit must be shared, UL-listed, twisted pair, and shielded wire must be used.

2-Wire Pulser

- Attach one wire to the terminal marked 'ENC INP'
- Attach one wire to the terminal marked 'GND'

3-Wire Pulser

- Attach 12V power line from the pulser to the terminal marked '12V DC'
- Attach signal wire to the terminal marked 'ENC INP'
- Attach the ground wire to the terminal marked 'GND'

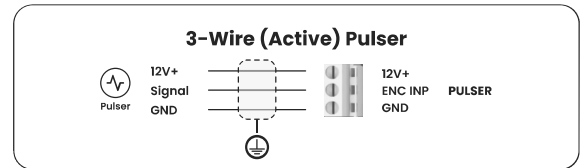
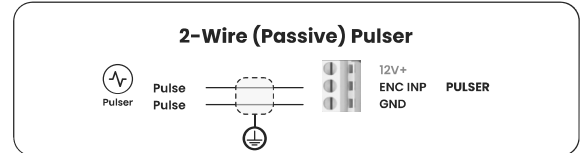
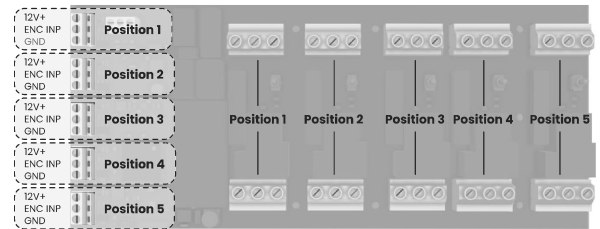

Certifications / Approvals

FuelCloud, Inc.

Fill-Rite FMS - NXFM150

RATINGS:

Max Ambient Temperature Rating: 50 °C

Input: 80-277VAC, 50/60 Hz 7.5A
12VDC, 7.5A

Output: 80-277VAC, 50/60 Hz 7.5A
12VDC, 7.5A

Enclosure: Type 4X

For supply connection use wires rated for at least 90C (194F)

For use with equipment specified in the installation instructions.

SEE INSTALLATION INSTRUCTIONS

WARNING SIGNAL WIRING IN THIS BOX MUST BE RATED AT LEAST 300V.

CAUTION: BONDING BETWEEN CONDUIT CONNECTIONS IS NOT AUTOMATIC AND MUST BE PROVIDED AS A PART OF THE INSTALLATION

ATTENTION: LE CABLAGE DE SIGNALISATION RACCORDÉ DANS CETTE DOITE DOIT CONVENIR POUR UNE TENSION NOMINALE D'AU MOINS 300V.

ATTENTION: L'INTERCONNEXION DES CONDUITS NE SUFFIT PAS POUR ASSURER LA MISE À LA MASSE; ELE DOIT FAIRE PARTIE INTEGRANTE DE L'INSTALLATION

This device complies with Part 15 of the FCC Rules. Operation is subject to the following two conditions: (1) this device may not cause harmful interference, and (2) this device must accept any interference received, including interference that may cause undesired operation.



FILL-RITE

Fill-Rite Company
8825 Aviation Drive
Fort Wayne, Indiana 46809 USA

T 1 (800) 720-5192
I 1 (260) 747-7524
F (800) 866-4681



fillrite.com | soter.com | gormanrupp.com